

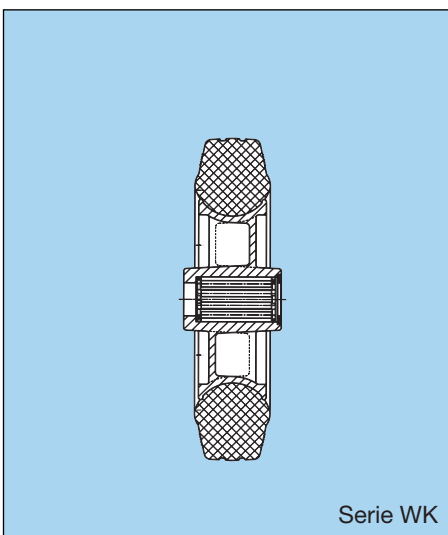









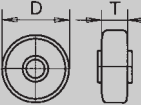

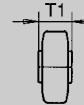
Räder mit STANDARD Vollgummibereifung grau und Kunststoff-Felgen Typ WK

Wheels with STANDARD grey rubber tyres and plastic centre type WK

Roues à bandages caoutchouc STANDARD gris montés sur corps plastique type WK

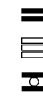

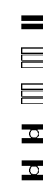
- | | | |
|---|---|---|
| <ul style="list-style-type: none"> ● Geräuscharmer Lauf ● Korrosionsunempfindlich ● nicht kreidend | <ul style="list-style-type: none"> ● Quiet running performance ● Corrosion resistant ● non marking | <ul style="list-style-type: none"> ● Roulement silencieux ● Résistant à la corrosion ● non tachant |
|---|---|---|

 mm x mm	 mm	 mm	 kg		Artikelbezeichnung Code-No. Référence-No.	Teile Nr. Identity-No. No. d'identification
80 x 25	12	40	50		WK 80/25/1 G	100627
					WK 80/25/1 R	100628
100 x 30	12	40	70		WK 100/30/1 G	100630
					WK 100/30/1 R	155492
125 x 38	15	50	100		WK 125/38/2 G	100634
					WK 125/38/2 R	155494
140 x 38	15	50	115		WK 140/38/2 G	100637
					WK 140/38/2 R	100638
160 x 40	20	60	135		WK 160/40/4 G	143857
					WK 160/40/4 R	143858
					WK 160/40/4 K	148542
180 x 50	20	60	170		WK 180/50/4 G	142343
					WK 180/50/4 R	155187
					WK 180/50/4 K	144200
200 x 50	20	60	205		WK 200/50/4 G	100645
					WK 200/50/4 R	100646
					WK 200/50/5 R	100648
					WK 200/50/4 K	100647
					WK 200/50/5 K	143859
250 x 60	25	75	295		WK 250/60/5 G	155188
					WK 250/60/5 R	119566

Lenkrollen mit STANDARD Vollgummibereifung Rad Type GK und WK

Swivel castors with STANDARD rubber tyres, wheel type GK and WK

Roulettes pivotantes avec roues à bandages caoutchouc STANDARD roue type GK et WK



Serie GK R



Serie GK R-FA-FSTF



Serie WK R-FA-FSTF



Serie WK R

- Lenkgabel aus Stahlblech, verzinkt
- Schwenklager mit zweifachem Kugelkranz
- Radachse verschraubt, Optionen:
● Fadenschutz...-FA
- Zapfenbefestigung

- Pressed steel swivel fork, zinc-plated
- Double ball race swivel head
- Bolted wheel axle, options:
● Thread guard...-FA
- Stem fitting

- Chape pivotante en tête d'acier emboutie, zinguée
- Double rangée de billes
- Axe de roue boulonné, options:
● Pare-fils...-FA
- Fixation à tige

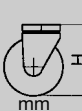
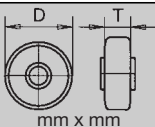

Artikelbezeichnung
Code-No.
Référence-No.

Teile Nr. / Ident-No.

FSTF

Lenkrollen mit Rückenloch, Rad GK schwarz

Swivel castors with bolt hole, wheel GK black

Roulettes pivotantes à œil, roue GK noire

80 x 25	13	69	99	36	50		GK R 01/ 80/25 G	155238	155239
							GK R 01/ 80/25 R	155240	155241
100 x 30	13	69	124	36	70		GK R 02/100/30 G	155242	155243
							GK R 02/100/30 R	155244	155246
125 x 38	13	69	154	36	100		GK RR 03/125/38 G	155247	155248
							GK RR 03/125/38 R	155249	155250
160 x 40	16,7	88	185	52	135		GK R 1/160/40 G	161702	161703
							GK R 1/160/40 R	161259	161704
							GK R 1/160/40 K	161705	161706
180 x 50	16,7	88	205	53	170		GK R 3/180/50 G	161707	161708
							GK R 3/180/50 R	161709	161710
							GK R 3/180/50 K	161711	161712
200 x 50	16,7	88	230	54	205		GK R 4/200/50 G	161713	161714
							GK R 4/200/50 R	161715	161716
							GK R 4/200/50 K	161717	161718

Lenkrollen mit Rückenloch, Rad WK grau

Swivel castors with bolt hole, wheel WK grey

Roulettes pivotantes à œil, roue WK gris

80 x 25	13	69	99	36	50		WK R 01/ 80/25 G	155251	155252
							WK R 01/ 80/25 R	155253	155254
100 x 30	13	69	124	36	70		WK R 02/100/30 G	155255	155256
							WK R 02/100/30 R	155257	155258
125 x 38	13	69	154	36	100		WK RR 03/125/38 G	155259	155260
							WK RR 03/125/38 R	145547	145544
160 x 40	16,7	88	185	52	135		WK R 1/160/40 G	161719	161720
							WK R 1/160/40 R	161721	161722
							WK R 1/160/40 K	161723	161724
180 x 50	16,7	88	205	53	170		WK R 3/180/50 G	161725	161726
							WK R 3/180/50 R	161727	161728
							WK R 3/180/50 K	161729	161730
200 x 50	16,7	88	230	54	205		WK R 4/200/50 G	161731	161732
							WK R 4/200/50 R	161733	161734
							WK R 4/200/50 K	161735	161736

Lenkrollen mit STANDARD Vollgummibereifung, Rad Type GK

Swivel castors with STANDARD rubber tyres, wheel type GK

Roulettes pivotantes avec roues à bandages caoutchouc STANDARD, roue type GK



- Lenkgabel aus Stahlblech, verzinkt
- Schwenklager mit zweifachem Kugelkranz und Abdichtung der oberen Kugelbahn
- Radachse verschraubt, Optionen:
- Fadenschutz...-FA
- Richtungsfeststeller...-RFST 1 x 360°

- Pressed steel swivel fork assembly, zinc-plated
- Swivel head with double ball race and sealing
- Wheel axle bolted, options:
- Thread guard...-FA
- Directional lock...-RFST 1 x 360°

- Chape en tôle d'acier emboutie, zinguée
- Double rangée de billes avec joint de protection
- Axe de roue boulonné, options:
- Pare-fils...-FA
- Frein directionnel...-RFST 1 x 360°

D		T	A	b1		G1	H	F	kg	Artikelbezeichnung Code-No. Référence-No.	Teile Nr. / Ident-No.		
mm x mm		mm	mm	a	b	mm	mm	mm			FSTR	FSTF	
80 x 25	105 x 80			80/76	60	9	100	36	50	GK L 01/ 80/25 G GK L 01/ 80/25 R	142722 142723	147990 141711	155496 145241
100 x 30	105 x 80			80/76	60	9	125	36	70	GK L 02/100/30 G GK L 02/100/30 R	142724 142725	117697 141713	151674 145242
125 x 38	105 x 80			80/76	60	9	155	36	100	GK LL 03/125/38 G GK LL 03/125/38 R	120110 120111	107634 130029	155093 145245
125 x 38	120 x 80			96	56	9	155	40	100	GK L 03/125/38 G GK L 03/125/38 R	120113 120114	118186 130027	155094 152872
125 x 38	135 x 110			105	75/80	11	155	48	100	GK L 015/125/38 G GK L 015/125/38 R	169676 169679	169677 169680	169678 169681
140 x 38	120 x 80			96	56	9	163	40	115	GK L 03/140/38 G GK L 03/140/38 R	120119 120120	118715 109105	- -
140 x 38	135 x 110			105	75/80	11	163	48	115	GK L 015/140/38 G GK L 015/140/38 R	169682 169684	169683 169685	- -
160 x 40	135 x 110			105	75/80	11	190	52	135	GK L 1/160/40 G GK L 1/160/40 R GK L 1/160/40 K	142713 142714 142715	155096 143819 155097	147765 145243 155098
180 x 50	135 x 110			105	75/80	11	210	53	170	GK L 3/180/50 G GK L 3/180/50 R GK L 3/180/50 K	142719 142720 142721	140614 140613 140615	155099 145478 155100
200 x 50	135 x 110			105	75/80	11	235	54	205	GK L 4/200/50 G GK L 4/200/50 R GK L 4/200/50 K	120132 142740 120134	118960 130035 114163	140604 145244 128708
250 x 60	135 x 110			105	75/80	11	290	66	295	GK LL 6/250/60 G GK LL 6/250/60 R	123717 107953	149740 134162	- -
250 x 60	175 x 175			140	140	14,5	290	70	295	GK L 6/250/60 G GK L 6/250/60 R	110012 110013	155102 123344	- -

Bockrollen mit STANDARD Vollgummibereifung, Rad Type GK

Fixed castors with STANDARD rubber tyres, wheel type GK

Roulettes fixes avec roues à bandages caoutchouc STANDARD, roue type GK



Serie GK B



Serie GK B-FA

- Bockgabel aus Stahlblech, verzinkt
- Radachse verschraubt, Option:
- Fadenschutz...-FA

- Pressed steel zinc-plated fixed fork
- Bolted wheel axle, option:
- Thread guard...-FA

- Chape fixe en tôle d'acier emboutie, zinguée
- Axe de roue boulonné, option:
- Pare-fils...-FA

												Artikelbezeichnung Code-No. Référence-No.	Teile Nr. Identity-No. No. d'identification
80 x 25	102 x 87	80 76	x 60	9	100	50						GK B 01/ 80/25 G GK B 01/ 80/25 R	142730 141718
100 x 30	102 x 87	80 76	x 60	9	125	70						GK B 02/100/30 G GK B 02/100/30 R	142732 141719
125 x 38	102 x 87	80 76	x 60	9	155	100						GK BB 03/125/38 G GK BB 03/125/38 R	142734 141720
125 x 38	120 x 80	96	x 56	9	155	100						GK B 03/125/38 G GK B 03/125/38 R	120147 120148
125 x 38	135 x 114	105 x 75 80		11	155	100						GK B 015/125/38 G GK B 015/125/38 R	169686 169687
140 x 38	120 x 80	96	x 56	9	163	115						GK B 03/140/38 G GK B 03/140/38 R	120153 120154
140 x 38	135 x 114	105 x 75 80		11	163	115						GK B 015/140/38 G GK B 015/140/38 R	169688 169689
160 x 40	135 x 114	105 x 75 80		11	190	135						GK B 1/160/40 G GK B 1/160/40 R GK B 1/160/40 K	142716 141721 142718
180 x 50	135 x 114	105 x 75 80		11	210	170						GK B 3/180/50 G GK B 3/180/50 R GK B 3/180/50 K	142736 142737 142738
200 x 50	135 x 114	105 x 75 80		11	235	205						GK B 4/200/50 G GK B 4/200/50 R GK B 4/200/50 K	120166 141722 120168
250 x 60	135 x 114	105 x 75 80		11	290	295						GK BB 6/250/60 G GK BB 6/250/60 R	128129 128130
250 x 60	230 x 125	190	x 75	14,5	290	295						GK B 6/250/60 G GK B 6/250/60 R	110014 110015

Lenkrollen mit STANDARD Vollgummibereifung, grau Rad Type WK

Swivel castors with STANDARD grey rubber tyres, wheel type WK

Roulettes pivotantes avec roues à bandages caoutchouc gris STANDARD, roue type WK



Serie WK L



Serie WK L-FSTR



Serie WK L-FSTF

- Lenkgabel aus Stahlblech, verzinkt
- Schwenklager mit zweifachem Kugelkranz und Abdichtung der oberen Kugelbahn
- Radachse verschraubt, Optionen:
- Fadenschutz...-FA
- Richtungsfeststeller...-RFST 1 x 360°

- Pressed steel fork assembly, zinc-plated
- Swivel head with double ball race and sealing
- Wheel axle bolted, options:
- Thread guard...-FA
- Directional lock...-RFST 1 x 360°

- Chape en tôle d'acier emboutie, zinguée
- Double rangée de billes avec joint de protection
- Axe de roue boulonné, options:
- Pare-fils...-FA
- Frein directionnel...-RFST 1 x 360°

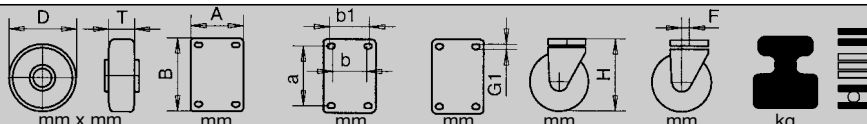

Artikelbezeichnung
Code-No.
Référence-No.

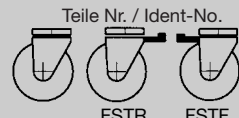

Teile Nr. / Ident-No.
FSTR FSTF

D	T	A	b1	a	G1	I	F	kg	Artikelbezeichnung	Code-No.	Référence-No.	Teile Nr. / Ident-No.	FSTR	FSTF
80 x 25	105 x 80	80/76 x 60	9	100	36	50	50	50	WK L 01/ 80/25 G	143620	155114	155115		
									WK L 01/ 80/25 R	143621	147505	152866		
100 x 30	105 x 80	80/76 x 60	9	125	36	70	70	70	WK L 02/100/30 G	120562	114596	149639		
									WK L 02/100/30 R	120501	118096	152867		
125 x 38	105 x 80	80/76 x 60	9	155	36	100	100	100	WK LL 03/125/38 G	120588	155116	155117		
									WK LL 03/125/38 R	120589	114627	152864		
125 x 38	120 x 80	96 x 56	9	155	40	100	100	100	WK L 03/125/38 G	120564	155118	155119		
									WK L 03/125/38 R	120565	108957	152868		
125 x 38	135 x 110	105 x 75/80	11	155	48	100	100	100	WK L 015/125/38 G	169690	169691	169692		
									WK L 015/125/38 R	169693	169694	169695		
140 x 38	120 x 80	96 x 56	9	163	40	115	115	115	WK L 03/140/38 G	120570	155122	-		
									WK L 03/140/38 R	120571	154022	-		
140 x 38	135 x 110	105 x 75/80	11	163	48	115	115	115	WK L 015/140/38 G	169696	169697	-		
									WK L 015/140/38 R	169698	169699	-		
160 x 40	135 x 110	105 x 75/80	11	190	52	135	135	135	WK L 1/160/40 G	155109	155125	155126		
									WK L 1/160/40 R	147026	147027	146213		
									WK L 1/160/40 K	148539	155127	152298		
180 x 50	135 x 110	105 x 75/80	11	210	53	170	170	170	WK L 3/180/50 G	155417	155128	155129		
									WK L 3/180/50 R	155418	155130	155131		
									WK L 3/180/50 K	144199	155132	155133		
200 x 50	135 x 110	105 x 75/80	11	235	54	205	205	205	WK L 4/200/50 G	120582	155134	155135		
									WK L 4/200/50 R	120583	115635	152528		
									WK L 4/200/50 K	120584	129416	152529		
250 x 60	135 x 110	105 x 75/80	11	290	66	295	295	295	WK LL 6/250/60 G	155110	155137	-		
									WK LL 6/250/60 R	155111	155138	-		
250 x 60	175 x 175	140 x 140	14,5	290	70	295	295	295	WK L 6/250/60 G	155112	155139	-		
									WK L 6/250/60 R	155113	155140	-		

Bockrollen mit STANDARD Vollgummibereifung, grau
Rad Type WK

Fixed castors with STANDARD grey rubber tyres
wheel type WK

Roulettes fixes avec roues à bandages caoutchouc gris
STANDARD
roue type WK



Serie WK B











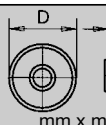
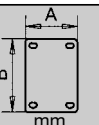
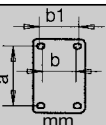
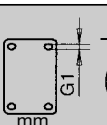
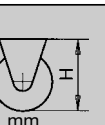





Serie WK B-FA

- Bockgabel aus Stahlblech, verzinkt
- Radachse verschraubt, Option:
- Fadenschutz...-FA

- Pressed steel zinc-plated fixed fork
- Bolted wheel axle, option:
- Thread guard...-FA

- Chape fixe en tôle d'acier emboutie, zinguée
- Axe de roue boulonné, option:
- Pare-fils...-FA

 mm x mm		 mm		 mm		 mm		 mm		 kg				Artikelbezeichnung Code-No. Référence-No.	Teile Nr. Identity-No. No. d'identification
80 x 25	102 x 87	80 76	60	9	100	50		WK B 01/ 80/25 G WK B 01/ 80/25 R	143609 143610						
100 x 30	102 x 87	80 76	60	9	125	70		WK B 02/100/30 G WK B 02/100/30 R	120595 120500						
125 x 38	102 x 87	80 76	60	9	155	100		WK BB 03/125/38 G WK BB 03/125/38 R	120621 120622						
125 x 38	120 x 80	96 x 56	9	155	100		WK B 03/125/38 G WK B 03/125/38 R	120597 120598							
125 x 38	135 x 114	105 x 75 80	11	155	100		WK B 015/125/38 G WK B 015/125/38 R	169700 169701							
140 x 38	120 x 80	96 x 56	9	163	115		WK B 03/140/38 G WK B 03/140/38 R	155141 154021							
140 x 38	135 x 114	105 x 75 80	11	163	115		WK B 015/140/38 G WK B 015/140/38 R	169702 169703							
160 x 40	135 x 114	105 x 75 80	11	190	135		WK B 1/160/40 G WK B 1/160/40 R WK B 1/160/40 K	155143 144342 148612							
180 x 50	135 x 114	105 x 75 80	11	210	170		WK B 3/180/50 G WK B 3/180/50 R WK B 3/180/50 K	155148 155149 144810							
200 x 50	135 x 114	105 x 75 80	11	235	205		WK B 4/200/50 G WK B 4/200/50 R WK B 4/200/50 K	120615 120616 120617							
250 x 60	135 x 114	105 x 75 80	11	290	295		WK BB 6/250/60 G WK BB 6/250/60 R	155172 155173							
250 x 60	230 x 125	190 x 75	14,5	290	295		WK B 6/250/60 G WK B 6/250/60 R	155174 155175							

Räder mit STANDARD Vollgummibereifung und Stahlblech-Felgen Typ GB

Wheels with STANDARD solid rubber tyres and pressed steel rims type GB

Roues à bandages caoutchouc STANDARD et jantes en tôle d'acier type GB



Serie GB

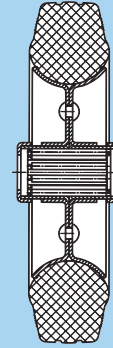

Serie GB

- Geräuscharmer Lauf
- Felgen: Stahlblech, verzinkt, mit Rollenlager

- Quiet running performance
- Rims: pressed steel zinc-plated with roller bearing

- Roulement silencieux
- Jantes: en tôle d'acier emboutie zinguée avec roulement à rouleaux

 mm x mm	 mm	 mm	 kg		Artikelbezeichnung Code-No. Référence-No.	Teile Nr. Identity-No. No. d'identification
80 x 25	12	40	50		GB 80/25/1 R	129118
100 x 30	12	40	70		GB 100/30/1 R	129119
125 x 38	15	50	100		GB 125/38/2 R	129120
140 x 38	15	50	115		GB 140/38/2 R	100481
160 x 40	20	60	135		GB 160/40/4 R	136593
180 x 50	20	60	170		GB 180/50/4 R	126333
200 x 50	20	60	205		GB 200/50/4 R	136594
200 x 65	20	75	250		GB 200/65/4 R	145985
250 x 60	25	75	295		GB 250/60/5 R	100494
250 x 70	25	75	295		GB 250/70/5 R	150204
280 x 70	30	75	385		GB 280/70/6 R	100496
400 x 75	25	75	475		GB 400/75/5 R	100500







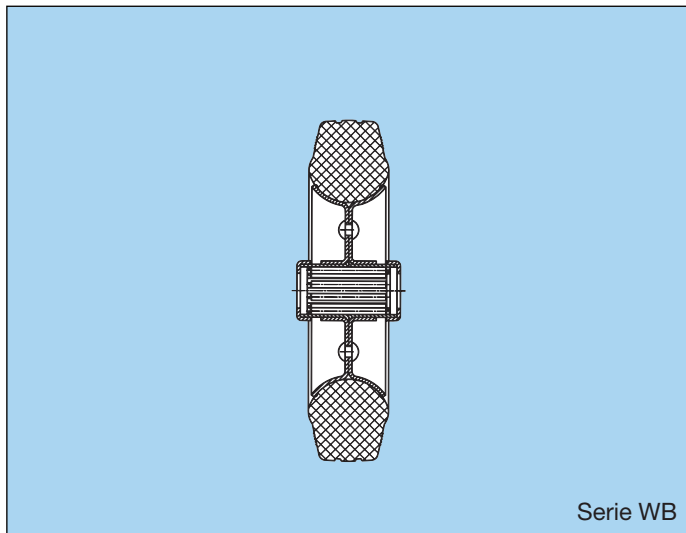

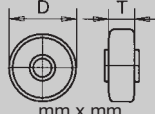
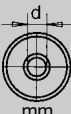
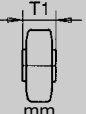

Räder mit STANDARD Vollgummibereifung, grau und Stahlblech-Felgen Typ WB

Wheels with STANDARD grey rubber tyres and pressed steel rims type WB

Roues à bandage gris caoutchouc STANDARD et jantes en tôle d'acier type WB



- | | | |
|---|---|---|
| <ul style="list-style-type: none"> ● Geräuscharmer Lauf ● Felgen: Stahlblech, verzinkt, mit Rollenlager ● nicht kreidend | <ul style="list-style-type: none"> ● Quiet running performance ● Rims: pressed steel zinc-plated with roller bearing ● non marking | <ul style="list-style-type: none"> ● Roulement silencieux ● Jantes: en tôle d'acier emboutie zinguée avec roulement à rouleaux ● non tachant |
|---|---|---|

 mm x mm	 mm	 mm	 kg		Artikelbezeichnung Code-No. Référence-No.	Teile Nr. Identity-No. No. d'identification
80 x 25	12	40	50		WB 80/25/1 R	100606
100 x 30	12	40	70		WB 100/30/1 R	100608
125 x 38	15	50	100		WB 125/38/2 R	108504
140 x 38	15	50	115		WB 140/38/2 R	100612
160 x 40	20	60	135		WB 160/40/4 R	149317
180 x 50	20	60	170		WB 180/50/4 R	148753
200 x 50	20	60	205		WB 200/50/4 R	100618
250 x 60	25	75	295		WB 250/60/5 R	100624

Lenkrollen mit STANDARD Vollgummibereifung und Stahlblech-Felgen, Rad Type GB und WB

Swivel castors with STANDARD solid rubber tyres and pressed steel rims, wheel type GB and WB

Roulettes pivotantes avec roues à bandages caoutchouc STANDARD et jantes en tôle d'acier type GB et WB



Serie GB R



Serie GB R-FA-FSTF



Serie WB R-FA-FSTF



Serie WB R

- Lenkgabeln aus Stahlblech, verzinkt
- Schwenklager mit zweifachem Kugelkranz
- Radachse verschraubt, Optionen:
- Fadenschutz...-FA
- Zapfenbefestigung

- Pressed steel swivel forks, zinc-plated
- Double ball race swivel head
- Bolted wheel axle, options:
- Thread guard...-FA
- Stem fitting

- Chapes pivotante en tôle d'acier emboutie, zinguée
- Double rangée de billes
- Axe de roue boulonné, options:
- Pare-fils...-FA
- Fixation à tige



Artikelbezeichnung
Code-No.
Référence-No.

Teile Nr. / Ident-No.
FSTF

Lenkrollen mit Rückenloch, Rad GB schwarz

Swivel castor with bolt hole, wheel GB black

Roulettes pivotantes à œil, roue GB noire

Wheel Size	Width	Height	Load Capacity	Swivel Head Height	Swivel Head Diameter	Swivel Head Weight	Swivel Head Icon	Article No.	Part No. 1	Part No. 2
80 x 25	13	69	99	36	50	50	[Icon]	GB R 01/ 80/25 R	152405	152404
100 x 30	13	69	124	36	70	70	[Icon]	GB R 02/100/30 R	155261	155262
125 x 38	13	69	154	36	100	100	[Icon]	GB RR 03/125/38 R	155263	155264
160 x 40	16,7	88	185	52	135	135	[Icon]	GB R 1/160/40 R	161737	161738
180 x 50	16,7	88	205	53	170	170	[Icon]	GB R 3/180/50 R	161739	161740
200 x 50	16,7	88	230	54	200	200	[Icon]	GB R 4/200/50 R	161741	161742

Lenkrollen mit Rückenloch, Rad WB grau

Swivel castor with bolt hole, wheel WB grey

Roulettes pivotantes à œil, roue WB gris

Wheel Size	Width	Height	Load Capacity	Swivel Head Height	Swivel Head Diameter	Swivel Head Weight	Swivel Head Icon	Article No.	Part No. 1	Part No. 2
80 x 25	13	69	99	36	50	50	[Icon]	WB R 01/ 80/25 R	155265	155266
100 x 30	13	69	124	36	70	70	[Icon]	WB R 02/100/30 R	155267	155268
125 x 38	13	69	154	36	100	100	[Icon]	WB RR 03/125/38 R	155269	155270
160 x 40	16,7	88	185	52	135	135	[Icon]	WB R 1/160/40 R	161743	161744
180 x 50	16,7	88	205	53	170	170	[Icon]	WB R 3/180/50 R	161745	161746
200 x 50	16,7	88	230	54	200	200	[Icon]	WB R 4/200/50 R	161747	161748

Lenkrollen mit STANDARD Vollgummibereifung und Stahlblech-Felgen, Rad Type GB

Swivel castors with STANDARD solid rubber tyres and pressed steel rims, wheel type GB

Roulettes pivotantes avec roues à bandages caoutchouc STANDARD et jantes en tôle d'acier type GB



Serie GB L



Serie GB L-FSTR



Serie GB L-FA-FSTF

- Lenkgabel aus Stahlblech, verzinkt
- Schwenklager mit zweifachem Kugelkranz und Abdichtung
- Radachse verschraubt
- Die mit ★ markierten Artikel werden generell mit Fadenschutz geliefert, Option:
- Richtungsfeststeller...-RFST 1 x 360°

- Pressed steel swivel fork zinc-plated
- Double ball race, sealed in the swivel head
- Bolted wheel axle
- The articles marked with ★ are generally supplied with thread guards, option:
- Directional lock...-RFST 1 x 360°

- Chape pivotantes en tôle d'acier emboutie, zinguée
- Double rangée de billes avec joint
- Axe de roue boulonné
- Les articles marqués avec ★ sont livrés en général avec pare-fils, option:
- Frein directionnel...-RFST 1 x 360°

										Artikelbezeichnung Code-No. Référence-No.		Teile Nr. / Ident-No. 		
mm x mm	mm	mm	mm	mm	mm	mm	kg					FSTR	FSTF	
80 x 25	105 x 80	80/76 x 60	9	100	36	50	★	GB L 01/80/25 R-FA	129112	129123	145236			
100 x 30	105 x 80	80/76 x 60	9	125	36	70	★	GB L 02/100/30 R-FA	139418	139419	145237			
125 x 38	105 x 80	80/76 x 60	9	155	36	100	★	GB LL 03/125/38 R-FA	139424	139420	145238			
125 x 38	120 x 80	96 x 56	9	155	40	100		GB L 03/125/38 R	120177	117362	155103			
125 x 38	135 x 110	105 x 75/80	11	155	48	100		GB L 015/125/38 R	164561	164562	169704			
140 x 38	120 x 80	96 x 56	9	163	40	115		GB L 03/140/38 R	120180	130028	-			
140 x 38	135 x 110	105 x 75/80	11	163	48	115		GB L 015/140/38 R	169705	169706	-			
160 x 40	135 x 110	105 x 75/80	11	190	52	135	★	GB L 1/160/40 R-FA	136595	147028	145239			
180 x 50	135 x 110	105 x 75/80	11	210	53	170		GB L 3/180/50 R	142745	148510	145479			
200 x 50	135 x 110	105 x 75/80	11	235	54	205	★	GB L 4/200/50 R-FA	136596	114686	145240			
200 x 65	135 x 110	105 x 75/80	11	245	61	250		GB L 5A/200/65 R	161749	161750	-			
250 x 60	135 x 110	105 x 75/80	11	290	66	295		GB LL 6/250/60 R	120503	116059	-			
250 x 60	175 x 175	140 x 140	14,5	290	70	295		GB L 6/250/60 R	120194	118052	-			

Bockrollen mit STANDARD Vollgummibereifung und Stahlblech-Felgen, Rad Type GB

Fixed castors with STANDARD solid rubber tyres and pressed steel rims, wheel type GB

Roulettes fixes avec roues à bandages caoutchouc STANDARD et jantes en tôle d'acier type GB



Serie GB B



Serie GB B-FA

- Bockgabel aus Stahlblech, verzinkt
- Radachse verschraubt
- Die mit ★ markierten Artikel werden generell mit Fadenschutz geliefert

- Pressed steel fixed fork zinc-plated
- Bolted wheel axle
- The articles marked with ★ are generally supplied with thread guards

- Chape fixe en tôle d'acier emboutie, zinguée
- Axe de roue boulonné
- Les articles marqués avec ★ sont livrés en général avec pare-fils

							Artikelbezeichnung Code-No. Référence-No.	Teile Nr. Identity-No. No. d'identification
mm x mm	mm	mm	mm	mm	kg			
80 x 25	102 x 87	$\frac{80}{76}$ x 60	9	100	50		★ GB B 01/ 80/25 R-FA	129115
100 x 30	102 x 87	$\frac{80}{76}$ x 60	9	125	70		★ GB B 02/100/30 R-FA	139417
125 x 38	102 x 87	$\frac{80}{76}$ x 60	9	155	100		★ GB BB 03/125/38 R-FA	139430
125 x 38	120 x 80	96 x 56	9	155	100		GB B 03/125/38 R	120205
125 x 38	135 x 114	$105 \times \frac{75}{80}$	11	155	100		GB B 015/125/38 R	164563
140 x 38	120 x 80	96 x 56	9	163	115		GB B 03/140/38 R	120208
140 x 38	135 x 114	$105 \times \frac{75}{80}$	11	163	115		GBB 015/140/38 R	169707
160 x 40	135 x 114	$105 \times \frac{75}{80}$	11	190	135		★ GB B 1/160/40 R-FA	136606
180 x 50	135 x 114	$105 \times \frac{75}{80}$	11	210	170		GB B 3/180/50 R	142741
200 x 50	135 x 114	$105 \times \frac{75}{80}$	11	235	205		★ GB B 4/200/50 R-FA	136605
200 x 65	135 x 114	$105 \times \frac{75}{80}$	11	245	250		GB B 5A/200/65 R	161751
250 x 60	135 x 114	$105 \times \frac{75}{80}$	11	290	295		GB BB 6/250/60 R	120222
250 x 60	230 x 125	190 x 75	14,5	290	295		GB B 6/250/60 R	120224

Lenkrollen mit STANDARD Vollgummibereifung grau Stahlblech-Felgen, Rad Type WB

Swivel castors with STANDARD grey solid rubber tyres and pressed steel rims, wheel type WB

Roulettes pivotantes avec roues à bandages caoutchouc gris STANDARD et jantes en tôle d'acier type WB



- Lenkgabel aus Stahlblech, verzinkt
- Schwenklager mit zweifachem Kugelkranz und Abdichtung
- Radachse verschraubt, Optionen:
- Fadenschutz...-FA
- Richtungsfeststeller...-RFST 1 x 360°

- Pressed steel swivel fork zinc-plated
- Double ball race, sealed in the swivel head
- Bolted wheel axle, options:
- Thread guard...-FA
- Directional lock...-RFST 1 x 360°

- Chape pivotante en tôle d'acier emboutie, zinguée
- Double rangée de billes avec joint
- Axe de roue boulonné, options:
- Pare-fils...-FA
- Frein directionnel...-RFST 1 x 360°

80 x 25	105 x 80	80/76 x 60	9	100	36	50		WB L	01/ 80/25 R	143625	147194	155142				
100 x 30	105 x 80	80/76 x 60	9	125	36	70		WB L	02/100/30 R	130370	133325	155144				
125 x 38	105 x 80	80/76 x 60	9	155	36	100		WB LL	03/125/38 R	144944	144945	155145				
125 x 38	120 x 80	96 x 56	9	155	40	100		WB L	03/125/38 R	130373	132080	155146				
125 x 38	135 x 110	105 x 75/80	11	155	48	100		WB L	015/125/38 R	169708	169709	169710				
140 x 38	120 x 80	96 x 56	9	163	40	115		WB L	03/140/38 R	120630	119239	-				
140 x 38	135 x 110	105 x 75/80	11	163	48	115		WB L	015/140/38 R	169711	169712	-				
160 x 40	135 x 110	105 x 75/80	11	190	52	135		WB L	1/160/40 R	148540	148637	151669				
180 x 50	135 x 110	105 x 75/80	11	210	53	170		WB L	3/180/50 R	148758	148759	155422				
200 x 50	135 x 110	105 x 75/80	11	235	54	205		WB L	4/200/50 R	120638	118095	155423				
250 x 60	135 x 110	105 x 75/80	11	290	66	295		WB LL	6/250/60 R	130375	107852	-				
250 x 60	175 x 175	140 x 140	14,5	290	70	295		WB L	6/250/60 R	130376	134806	-				

Bockrollen mit STANDARD Vollgummibereifung, grau und Stahlblech-Felgen, Rad Type WB

Fixed castors with STANDARD grey solid rubber tyres and pressed steel rims, wheel type WB

Roulettes fixes avec roues à bandages caoutchouc gris STANDARD et jantes en tôle d'acier type WB



Serie WB B



Serie WB B-FA

- Bockgabel aus Stahlblech verzinkt
- Radachse verschraubt, Option:
- Fadenschutz...-FA

- Pressed steel fixed fork zinc-plated
- Bolted wheel axle, option:
- Thread guard...-FA

- Chape fixe en tôle d'acier emboutie, zinguée
- Axe de roue boulonné, option:
- Pare-fils...-FA

							Artikelbezeichnung Code-No. Référence-No.	Teil Nr. Identity-No. No. d'identification
80 x 25	102 x 87	80/76 x 60	9	100	50		WB B 01/ 80/25 R	143615
100 x 30	102 x 87	80/76 x 60	9	125	70		WB B 02/100/30 R	130405
125 x 38	102 x 87	80/76 x 60	9	155	100		WB BB 03/125/38 R	130407
125 x 38	120 x 80	96 x 56	9	155	100		WB B 03/125/38 R	130408
125 x 38	135 x 114	105 x 75/80	11	155	100		WB B 015/125/38 R	169713
140 x 38	120 x 80	96 x 56	9	163	115		WB B 03/140/38 R	120643
140 x 38	135 x 114	105 x 75/80	11	163	115		WB B 015/140/38 R	169714
160 x 40	135 x 114	105 x 75/80	11	190	135		WB B 1/160/40 R	148611
180 x 50	135 x 114	105 x 75/80	11	210	170		WB B 3/180/50 R	148760
200 x 50	135 x 114	105 x 75/80	11	235	205		WB B 4/200/50 R	120651
250 x 60	135 x 114	105 x 75/80	11	290	295		WB BB 6/250/60 R	130410
250 x 60	230 x 125	190 x 75	14,5	290	295		WB B 6/250/60 R	130411