

**Inox Lenk- und Bockrollen mit Polyamid-Rädern Type KN**

**Stainless steel swivel and fixed castors with Polyamide wheels type KN**

**Roulettes pivotantes et fixes en Inox avec roues en Polyamide type KN**



- Gabel aus rostfreiem Stahlblech
- Schwenklager mit zweifachem Kugelkranz
- Radachse rostfrei, verschraubt

- Pressed steel stainless steel fork
- Double ball race swivel head
- Stainless steel bolted wheel axle

- Chapes en tôle d'acier emboutie Inox
- Double rangée de billes
- Axe de roue en Inox boulonné

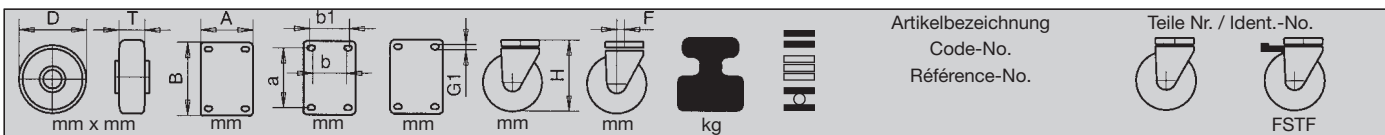

Lenkrollen				Swivel castors			Roulettes pivotantes			
80 x 35	105 x 85	80 x 60	9	106	38	100	≡	KN LI 01/ 80/35 G	142303	143847
100 x 38	105 x 85	80 x 60	9	128	40	135	≡	KN LI 02/100/38 G	142304	143341
125 x 38	105 x 85	80 x 60	9	155	45	180	≡	KN LLI 03/125/38 G	142305	143495
150 x 40	135 x 110	105 x $\frac{75}{80}$	11	194	55	250	≡	KN LI 1/150/40 G	142307	-
175 x 48	135 x 110	105 x $\frac{75}{80}$	11	223	55	275	≡	KN LI 4/175/48 G	142308	-
200 x 50	135 x 110	105 x $\frac{75}{80}$	11	235	55	300	≡	KN LI 4/200/50 G	142309	143849

Bockrollen				Fixed castors			Roulettes fixes			
80 x 35	105 x 85	80 x 60	9	108		100	≡	KN BI 01/ 80/35 G	142310	
100 x 38	105 x 85	80 x 60	9	128		135	≡	KN BI 02/100/38 G	142311	
125 x 38	105 x 85	80 x 60	9	155		180	≡	KN BBI 03/125/38 G	142312	
150 x 40	135 x 110	105 x $\frac{75}{80}$	11	190		250	≡	KN BI 1/150/40 G	142314	
175 x 48	135 x 110	105 x $\frac{75}{80}$	11	223		275	≡	KN BI 4/175/48 G	142315	
200 x 50	135 x 110	105 x $\frac{75}{80}$	11	235		300	≡	KN BI 4/200/50 G	142316	

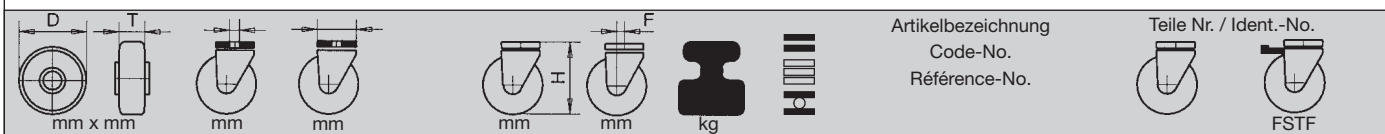

Lenkrollen mit Rückenloch			Swivel castors with bolt hole			Roulettes pivotantes à œil			
80 x 35	12,2	66	108	38	100	≡	KN RI 01/ 80/35 G	153545	153546
100 x 38	12,2	66	130	40	135	≡	KN RI 02/100/38 G	153547	153548
125 x 38	12,2	66	156	45	180	≡	KN RRI 03/125/38 G	153549	153550

# Räder, Lenk- und Bockrollen mit Halbelastik-Vollgummibereifung und Stahlblech-Felgen Typ SB

# Wheels, swivel and fixed castors with semi-elastic rubber tyres, and pressed steel rims type SB

# Roues, roulettes pivotantes et fixes à bandages caoutchouc semi-élastiques et jantes en tôle d'acier type SB



- Gute Verschleißfestigkeit
- Hohe Tragfähigkeit bei niedrigem Rollwiderstand
- Felgen: Stahlblech, verzinkt, mit Rollenlager

- High resistance against abrasion
- Low rolling resistance under high loads
- Rims: pressed steel zinc-plated with roller bearing

- Bonne résistance à l'usure
- Faible résistance au roulement sous fortes charges
- Jantes: en tôle d'acier emboutie zinguée avec roulement à rouleaux



Räder	Wheels	Roues			
125 x 38	15	50	120	SB 125/38/2 R	100559
160 x 40	20	60	225	SB 160/40/4 R	142382
200 x 50	20	60	350	SB 200/50/4 R	100563
250 x 60	25	75	450	SB 250/60/5 R	100567

- Lenk- und Bockgabel aus Stahlblech, verzinkt
- Schwenklager mit zweifachem Kugelkranz und Abdichtung der oberen Kugelbahn
- Radachse verschraubt, Optionen: Fadenschutz...-FA
- Richtungsfeststeller...-RFST 1 x 360°

- Pressed steel zinc plated fork
- Double ball race with sealing
- Bolted wheel axle, options: Thread guard...-FA
- Directional lock...-RFST 1 x 360°

- Chape en tôle d'acier emboutie, zinguée
- Double rangée de billes, avec joint de protection
- Axe de roue boulonné, options: Pare-fils...-FA
- Frein directionnel...-RFST 1 x 360°

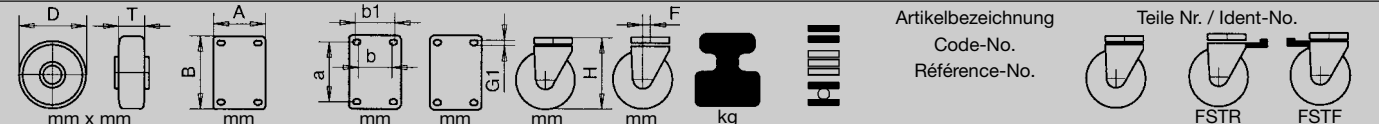

Lenkrollen	Swivel castors	Roulettes pivotantes								
125 x 38	120 x 80	96 x 56	9	155	40	120	SB L 03/125/38 R	120228	118093	155101
125 x 38	135 x 110	105 x 75/80	11	155	48	120	SB L 015/125/38 R	169715	169716	169717
160 x 40	135 x 110	105 x 75/80	11	190	52	225	SB L 1/160/40 R	142383	143863	153006
200 x 50	135 x 110	105 x 75/80	11	235	54	350	SB L 4/200/50 R	120234	130036	115026
250 x 60	135 x 110	105 x 75/80	11	290	66	400	SB LL 6/250/60 R	120236	130068	-
250 x 60	175 x 175	140 x 140	14,5	290	70	450	SB L 6/250/60 R	120238	118797	-

Bockrollen	Fixed castors	Roulettes fixes					
125 x 38	120 x 80	96 x 56	9	155	120	SB B 03/125/38 R	120242
125 x 38	135 x 114	105 x 75/80	11	155	120	SB B 015/125/38 R	169718
160 x 40	135 x 114	105 x 75/80	11	190	225	SB B 1/160/40 R	142384
200 x 50	135 x 114	105 x 75/80	11	235	350	SB B 4/200/50 R	120248
250 x 60	135 x 114	105 x 75/80	11	290	400	SB BB 6/250/60 R	120250
250 x 60	230 x 125	190 x 75	14,5	290	450	SB B 6/250/60 R	120252

**WICKE-ELASTIC Schwerlast-  
räder mit Vollgummibereifung  
und Felgen in Guß Type GG  
oder Stahlschweißkonstruktion  
Type GS**

**WICKE-ELASTIC heavy duty  
wheels with solid rubber  
tyres and cast iron rims type  
GG or welded steel rims  
type GS**

**WICKE-ELASTIC roues pour  
charges lourdes à bandages  
caoutchouc et jantes en fonte  
type GG ou en acier mécano-  
soudé type GS**

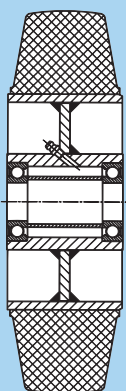

Serie GS



Serie GS

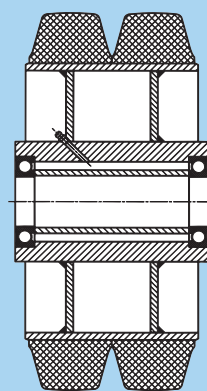

Serie GS

- Aufgepreßter Vollgummireifen mit Stahldrahtarmierung
- Mit Schmiernippel
- Nabe mit 2 Rillenkugellagern
- Hohe Elastizität bei geringem Rollwiderstand

- Press-on solid elastic rubber tyres with wire mesh base
- With grease nipple
- Hub with 2 precision ball bearings
- High elasticity with low rolling resistance

- Bandages caoutchouc élastique avec armatures métalliques montés à la presse sur les jantes
- Avec graisseur
- Moyeu avec deux roulements à billes de précision
- Grande élasticité avec une faible résistance au roulement

D	T		d	T1	M			Artikelbezeichnung Code-No. Référence-No.	Teile Nr. Identity-No. No. d'identification
mm x mm	mm	mm	mm	mm	mm	kg			

400 x 65	305	30	75	100	900		GG 400/ 65/ 6 K	155348
400 x 65	305	35	75	100	900		GG 400/ 65/ 7 K	155349
400 x 75	305	35	90	100	1000		GG 400/ 75/ 7 K	155350
405 x 130	305	40	140	102	1500		GG 405/ 130/ 8 K	155351
415 x 90	305	40	120	100	1150		GG 415/ 90/ 8 K	155352
415 x 100	305	40	120	100	1250		GG 415/ 100/ 8 K	155353
425 x 150	305	40	160	100	1800		GG 425/ 150/ 8 K	155354
455 x 100	305	40	120	100	1400		GG 455/ 100/ 8 K	155355
500 x 65	410	40	75	100	1100		GS 500/ 65/ 8 K	100787
500 x 85	370	40	90	100	1300		GS 500/ 85/ 8 K	100789
520 x 120	370	40	120	100	1525		GS 520/ 100/ 8 K	100793
550 x 120	410	45	130	108	1825		GS 550/ 120/ 9 K	100798
550 x 160	410	50	170	114	2250		GS 550/ 160/10 K	100799
610 x 150	410	50	160	114	2250		GS 610/ 150/10 K	100802
620 x 200	410	50	210	114	3000		GS 620/ 200/10 K	100803

Zwillingsräder			Twin wheel types				Roues jumelées		
200 x 2 x 50	140	25	120	76	700		GS 200/2x 50/ 5 K	134068	
200 x 2 x 75	100	25	160	100	1000		GS 200/2x 75/ 5 K	100725	
230 x 2 x 50	170	30	120	76	800		GS 230/2x 50/ 6 K	100728	
250 x 2 x 75	140	30	160	76	1250		GS 250/2x 75/ 6 K	100739	
250 x 2 x 60	170	30	150	76	1100		GS 250/2x 60/ 6 K	131569	
260 x 2 x 60	170	30	130	76	1050		GS 260/2x 60/ 6 K	100743	
280 x 2 x 75	220	35	160	89	1450		GS 280/2x 75/ 7 K	100751	
300 x 2 x 75	220	30	180	76	1500		GS 300/2x 75/ 6 K	134069	
300 x 2 x 85	170	35	180	90	1600		GS 300/2x 85/ 7 K	100762	
360 x 2 x 60	270	30	150	76	1500		GS 360/2x 60/ 6 K	134070	
360 x 2 x 75	270	35	160	90	1900		GS 360/2x 75/ 7 K	100771	
400 x 2 x 65	305	40	140	100	1800		GG 400/2x 65/ 8 K	155356	
400 x 2 x 75	305	40	160	100	2000		GG 400/2x 75/ 8 K	155357	
415 x 2 x 90	305	40	190	100	2300		GS 415/2x 90/ 8 K	100782	
500 x 2 x 65	410	40	140	100	2200		GS 500/2x 65/ 8 K	100790	
550 x 2 x 160	410	60	340	133	4500		GS 550/2x160/12 K	110054	

**WICKE-ELASTIC Schwerlast Flanschräder mit Vollgummibereifung, Felgen in Stahlschweißkonstruktion**

**WICKE-ELASTIC heavy duty drive wheels with press-on solid rubber tyres and welded steel rims**

**WICKE-ELASTIC roues sans moyeu pour charges lourdes à bandage caoutchouc et jantes en acier mécano-soudé**



Serie GS

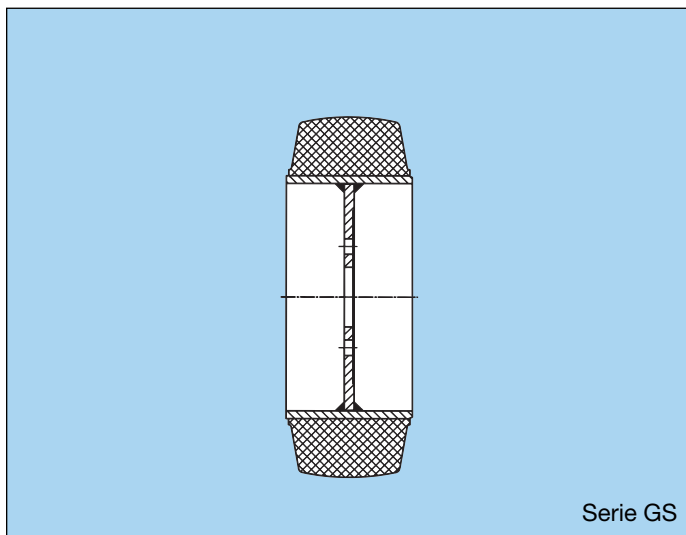





Serie GS

- Fester Reifensitz durch Stahlarmierung oder Stahlband im Reifenfuß
- Hohe Elastizität bei geringem Rollwiderstand
- Auf Anfrage auch lieferbar mit WICKE-TOPHTHANE®-Reifen

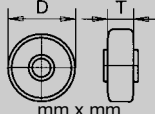
- Strong press-fit on the rim due to wire-mesh or steel band foot in the tyre base
- High elasticity combined with low rolling resistance
- Also available on request with WICKE-TOPHTHANE®-tyre

- Bon maintien du bandage grâce à armature métallique ou frette acier en socle de bandage
- Grande élasticité avec résistance au roulement très faible
- Aussi disponible avec bandage WICKE-TOPHTHANE® sur demande

 mm x mm	 mm	 mm	 kg	Artikelbezeichnung Code-No. Référence-No.
200 x 75	100	0	500	GS 200/ 75/FL
250 x 60	190	0	525	GS 250/ 60/FL
250 x 80	170	0	675	GS 250/ 80/FL
250 x 105	170	0	610	GS 250/105/FL
260 x 60	170	0	525	GS 260/ 60/FL
280 x 60	190	0	575	GS 280/ 60/FL
280 x 75	220	0	725	GS 280/ 75/FL
300 x 75	220	0	750	GS 300/ 75/FL
300 x 85	170	0	800	GS 300/ 85/FL
300 x 90	203	0	900	GS 300/ 90/FL
300 x 100	203	0	975	GS 300/100/FL
360 x 60	270	0	750	GS 360/ 60/FL
360 x 85	270	0	1050	GS 360/ 85/FL
400 x 75	305	0	1000	GS 400/ 75/FL
415 x 100	305	0	1250	GS 415/100/FL
455 x 100	305	0	1400	GS 455/100/FL
500 x 65	410	0	1100	GS 500/ 65/FL
500 x 85	370	0	1300	GS 500/ 85/FL
520 x 100	370	0	1525	GS 520/100/FL
560 x 100	410	0	1600	GS 560/100/FL
610 x 150	410	0	2250	GS 610/150/FL
620 x 200	410	0	3000	GS 620/200/FL
645 x 200	480	0	3100	GS 645/200/FL
660 x 250	480	0	3750	GS 660/250/FL

Anschlußmaße nach DIN z.B. 4/60/100, 5/67/112, 5/82/130 oder nach Bedarf

Fitting size accordance with DIN standard e.g.: 4/60/100, 5/67/112, 5/82/130 or as requested

Dimension de raccordement suivant DIN par ex.: 4/60/100, 5/67/112, 5/82/130 ou sur demande

**WICKE-ELASTIC federnde Lenk- und Bockrollen in Stahlschweißkonstruktion mit Rad Type DE / GG / GF**

**WICKE-ELASTIC spring-action swivel and fixed castors in welded steel construction with wheel type DE / GG / GF**

**WICKE-ELASTIC roulettes pivotantes et fixes à suspension en acier mécano-soudé avec roue type DE / GG / GF**



Serie DE LKF

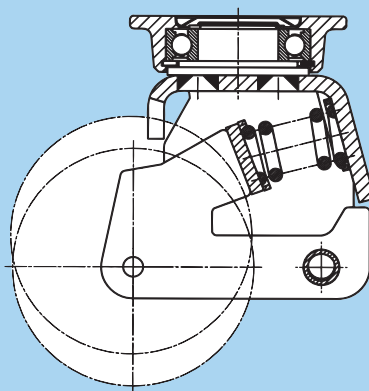

Serie LKF



Serie DE BKF

- Gabelkopf mit Original-Präzisions-Kugellager im Drehkranz, dauergeschmiert
- Fv = Federvorspannkraft  
Fe = Federendkraft

- Swivel head with precision ball bearing, permanent lubrication
- Fv = required load for start of spring action  
Fe = maximum load (end) for spring action

- Tête de pivotement avec roulement à billes de précision et graissage permanent
- Fv = début d'écrasement du ressort  
Fe = fin d'écrasement du ressort

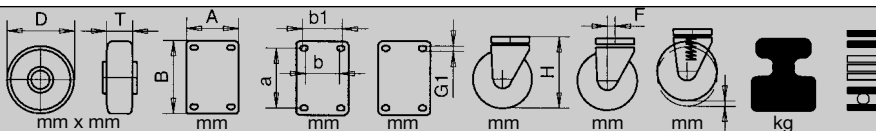

Artikelbezeichnung  
Code-No.  
Référence-No.

Teile-Nr.  
Identity-No.  
No. d'identification

Lenkrollen				Swivel castors				Roulettes pivotantes		
100 x 40	135 x 110	105 x $\frac{75}{80}$	11	168	30	15	180		DE LKF 3/0/100/40 K Fv = 50 kg Fe = 200 kg	129045
125 x 40	135 x 110	105 x $\frac{75}{80}$	11	190	45	15	200		DE LKF 3/1/125/40 K Fv = 50 kg Fe = 200 kg	129046
150 x 50	135 x 110	105 x $\frac{75}{80}$	11	233	65	20	300		DE LKF 3/3/150/50 K Fv = 30 kg Fe = 350 kg	129047
160 x 50	135 x 110	105 x $\frac{75}{80}$	11	238	65	20	300		DE LKF 3/3/160/50 K Fv = 50 kg Fe = 350 kg	129048
200 x 50	135 x 110	105 x $\frac{75}{80}$	11	290	95	25	400		DE LKF 3/4/200/50 K Fv = 50 kg Fe = 390 kg	129049
250 x 80	200 x 160	$\frac{170 \times 130}{160 \times 120}$	13	356	155	20	675		GF LAKF 3/6/250/80 K Fv = 180 kg Fe = 680 kg	155457
280 x 75	200 x 160	$\frac{170 \times 130}{160 \times 120}$	13	371	155	20	725		GG LAKF 3/7/280/75 K Fv = 180 kg Fe = 680 kg	155458
300 x 75	200 x 160	$\frac{170 \times 130}{160 \times 120}$	13	381	155	20	750		GG LAKF 3/7/300/75 K Fv = 180 kg Fe = 680 kg	155459
360 x 75	200 x 160	$\frac{170 \times 130}{160 \times 120}$	13	477	155	30	950		GG LAKF 3/8/360/75 K Fv = 50 kg Fe = 810 kg	155460
Bockrollen				Fixed castors				Roulettes fixes		
100 x 40	135 x 110	105 x $\frac{75}{80}$	11	168	30	15	180		DE BKF 3/0/100/40 K Fv = 50 kg Fe = 200 kg	129054
125 x 40	135 x 110	105 x $\frac{75}{80}$	11	190	45	15	200		DE BKF 3/1/125/40 K Fv = 50 kg Fe = 200 kg	129055
150 x 50	135 x 110	105 x $\frac{75}{80}$	11	233	65	20	300		DE BKF 3/3/150/50 K Fv = 30 kg Fe = 350 kg	129056
160 x 50	135 x 110	105 x $\frac{75}{80}$	11	238	65	20	300		DE BKF 3/3/160/50 K Fv = 30 kg Fe = 350 kg	129057
200 x 50	135 x 110	105 x $\frac{75}{80}$	11	290	95	25	400		DE BKF 3/4/200/50 K Fv = 50 kg Fe = 390 kg	129058
250 x 80	200 x 160	$\frac{170 \times 130}{160 \times 120}$	13	356	155	20	675		GF BAKF 3/6/250/80 K Fv = 180 kg Fe = 680 kg	155461
280 x 75	200 x 160	$\frac{170 \times 130}{160 \times 120}$	13	371	155	20	725		GG BAKF 3/7/280/75 K Fv = 180 kg Fe = 680 kg	155462
300 x 75	200 x 160	$\frac{170 \times 130}{160 \times 120}$	13	381	155	20	750		GG BAKF 3/7/300/75 K Fv = 180 kg Fe = 680 kg	155463
360 x 75	200 x 160	$\frac{170 \times 130}{160 \times 120}$	13	477	155	30	950		GG BAKF 3/8/360/75 K Fv = 50 kg Fe = 810 kg	155464

**WICKE-TOPTHANE®**  
**Stahlbandreifen**  
**(Polyurethan 92 Shore A)**

**WICKE-TOPTHANE®**  
**Steel band tyres**  
**(Polyurethane 92 Shore A)**

**WICKE-TOPTHANE®**  
**Bandages à frette acier**  
**(Polyurethane 92 Shore A)**



Serie PU

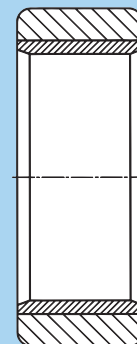

Serie PU

- Der WICKE-TOPTHANE®-Belag ist durch einen chemischen Haftvermittler fest mit dem Stahlband verbunden
- Stahlbandbandagen werden auf Guß- oder Stahlkerne aufgepreßt, Felgentoleranz nach DIN 7845

- The WICKE-TOPTHANE® coating is firmly adhered to the steelband by a chemical adhesive
- Steel band tyres are pressed on cast iron or steel wheel centres, rim tolerance according to DIN 7845

- Bandage WICKE-TOPTHANE® moulé sur frette acier
- Montage par presse sur jantes en fonte ou acier, tolérance pour les jantes suivant DIN 7845

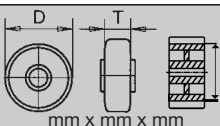

kg  
6 km/h

Artikelbezeichnung  
Code-No.  
Référence-No.

Teile Nr.  
Identity-No.  
No. d'identification

**Zylindrisch**

**Cylindric**

**Cylindrique**

150 x 75 - 100	FL	Z ST	1000	PU 150/ 75-100 Z ST FL	121238
170 x 40 - 125	FL	Z ST	600	PU 170/ 40-125 Z ST FL	154295
180 x 50 - 120	FL	Z ST	720	PU 180/ 50-120 Z ST FL	160685
200 x 75 - 100	FL	Z ST	1040	PU 200/ 75-100 Z ST FL	162495
200 x 105 - 120	FL	Z ST	1600	PU 200/105-120 Z ST FL	160013
250 x 80 - 170	FL	Z ST	1495	PU 250/ 80-170 Z ST FL	141517
250 x 105 - 170	FL	Z ST	1965	PU 250/105-170 Z ST FL	160688
250 x 130 - 140	FL	Z ST	2300	PU 250/130-140 Z ST FL	118401
260 x 105 - 170	FL	Z ST	2000	PU 260/105-170 Z ST FL	146249
285 x 100 - 228	FL	Z ST	2400	PU 285/100-228 Z ST FL	159728
300 x 90 - 203	FL	Z ST	1900	PU 300/ 90-203 Z ST FL	154177
300 x 100 - 203	FL	Z ST	2105	PU 300/100-203 Z ST FL	162255
300 x 100 - 225	FL	Z ST	2400	PU 300/100-225 Z ST FL	131499
300 x 100 - 230	FL	Z ST	2450	PU 300/100-230 Z ST FL	159734
300 x 100 - 230	FL	Z ST	2500	PU 300/100-230 Z ST FL	163252
300 x 110 - 203	FL	Z ST	2470	PU 300/100-203 Z ST FL	159731
310 x 100 - 230	FL	Z ST	2500	PU 310/100-230 Z ST FL	164676
343 x 114 - 225	FL	Z ST	2730	PU 343/114-225 Z ST FL	160753
343 x 114 - 254	FL	Z ST	3000	PU 343/114-254 Z ST FL	160750
343 x 115 - 245	FL	Z ST	2900	PU 343/115-245 Z ST FL	162494
350 x 110 - 270	FL	Z ST	3000	PU 350/110-270 Z ST FL	154180
415 x 90 - 305	FL	Z ST	2600	PU 415/ 90-305 Z ST FL	110802

**Kerbverzahnung**

**Teeth fitting**

**Bandage ondulé interieur**

210 x 70 - 168	FL	Z ST	1200	PU 210/ 70-168 KV FL	128339
270 x 90 - 220	FL	Z ST	1500	PU 270/ 90-220 KV FL	160682